

Grobfilter PN 4

Aluminiumguss, Durchgangsform

- Flanschbohrungen nach DIN PN 10
- Gehäusemaße nach DIN 87151
- Verwendung: Vorwiegend in Saug- und Druckleitungen, z.B. der Kühlwasser und Lenzanlagen
- Sieb aus nichtrostendem Stahl mit 8 mm Quadratlochung oder 5 mm Rundlochung
andere Werkstoffe und Lochungen auf Anfrage

Mud Box PN 4

cast aluminium, straight pattern

- flange drilling acc. to DIN PN 10
- body dimensions acc. to DIN 87151
- application: mainly for use in suction and discharge pipelines, e.g. cooling water- and bilge systems
- screen of stainless steel with 8 mm square holes or 5 mm round holes
others on request



Abb. / figure: DN 80



Pos. item	Bezeichnung denomination	AW 600.6	Pos. item	Bezeichnung denomination	AW 600.6
1	Gehäuse / body	G-AISI7Mg0,3wa EN AC-42100 T6	7	Dichtung / gasket	NBR
2	Deckel / cover	G-AISI7Mg0,3wa EN AC-42100 T6	8	Entleerungsschraube / drain bolt	CuZn39Pb2 CW612N
3	Sieb / screen	X5CrNi18-10 1.4301	9	Entlüftungskugelhahn / vent ball valve (optional)	CuZn39Pb2 galv. CW612N
4	Stiftschraube / stud bolt	5.8			
5	Mutter / nut	CuZn39Pb2 CW612N			
6	Ringschraube / ring bolt	C15E 1.1141			

DN	PN	L	L ₁	h	H	Øb	ØD	Øk	n	Ød	Normalleistung m ³ /h* normal capacity m ³ /h*	≈kg
32	4,0	200	100	95	202	202	150	100	4	18	6,8	4,5
40	4,0	200	100	95	202	202	150	110	4	18	6,8	4,5
50	4,0	230	115	106	224	242	165	125	4	18	10,6	6,5
65	4,0	290	145	134	263	268	185	145	4	18	18,0	8,5
80	4,0	310	155	156	299	296	200	160	8	18	30,0	11,5
100	4,0	350	175	185	339	326	220	180	8	18	42,2	14,0
125	4,0	400	200	229	416	394	250	210	8	18	66,2	21,5
150	4,0	480	240	268	468	442	285	240	8	22	95,4	29,0

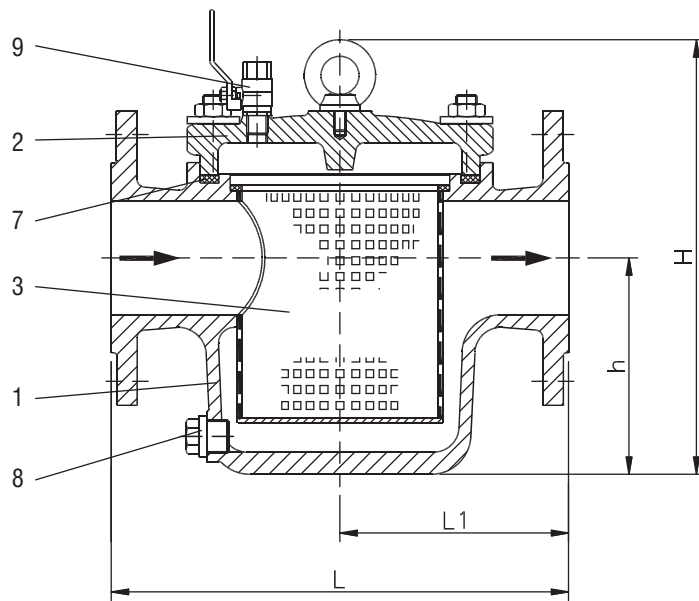
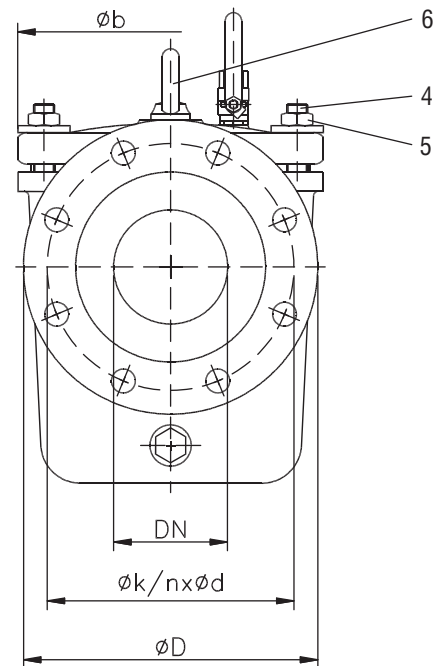
*:1,5 m/s

Grobfilter PN 2,5

Sphäroguss, Eckform

- Flanschbohrungen nach DIN PN 10
- Verwendung: Vorwiegend in Saug- und Druckleitungen, z.B. der Kühlwasser und Lenzanlagen
- Sieb aus nichtrostendem Stahl mit 8 mm Quadratlochung oder 5 mm Rundlochung
andere Werkstoffe und Lochungen auf Anfrage

Mud Box PN 2,5

nodular cast iron, angle pattern

- flange drilling acc. to DIN PN 10
- application: mainly for use in suction and discharge pipelines, e.g. cooling water- and bilge systems
- screen of stainless steel with 8 mm square holes or 5 mm round holes
others on request

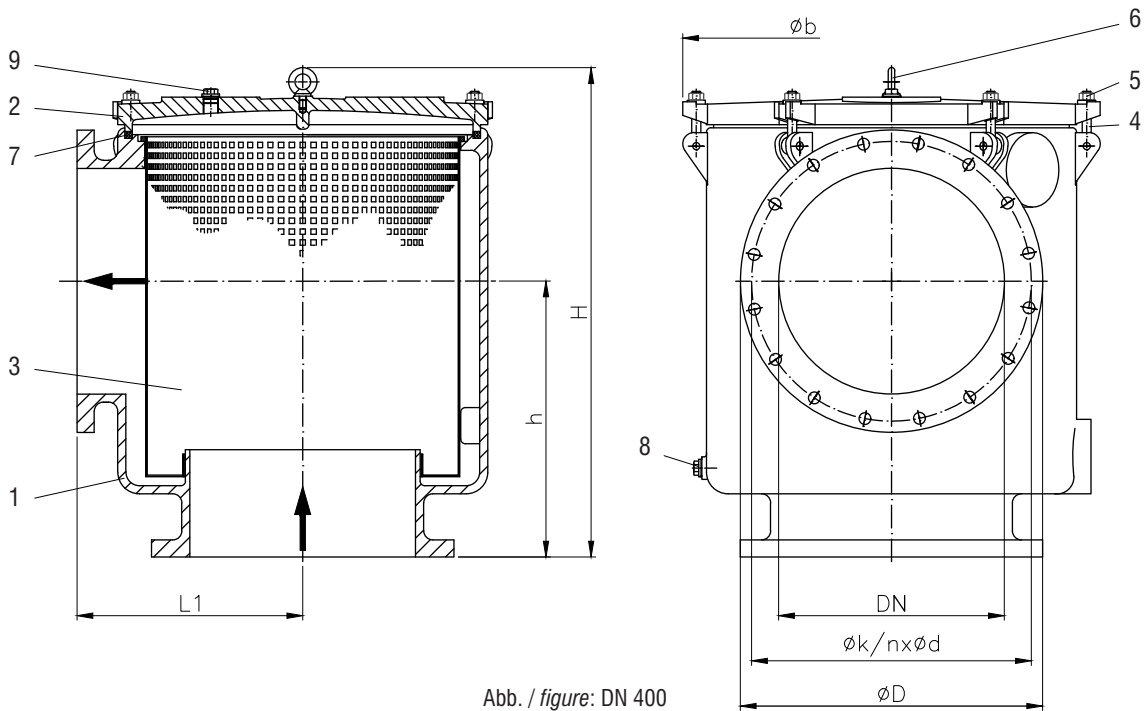

Abb. / figure: DN 400

Pos. / item	Bezeichnung / denomination	AW 609.0		Pos. / item	Bezeichnung / denomination	AW 609.0	
1	Gehäuse / body	EN-GJS-400-15	EN-JS1030	7	Dichtung / gasket	NBR	
2	Deckel / cover	EN-GJS-400-15	EN-JS1030	8	Entleerungsschraube / drain bolt	CuZn39Pb2	CW612N
3	Sieb / screen	X5CrNi18-10	1.4301	9	Entlüftungskugelhahn / vent ball valve (optional)	CuZn39Pb2 galv.	CW612N
4	Augenschraube / eye bolt	5.8					
5	Mutter / nut	CuZn39Pb2 CW612N					
6	Ringschraube / ring bolt	C15E 1.1141					

DN	PN	L1	h	H	øb	øD	øk	n	ød	Normalleistung m ³ /h* normal capacity m ³ /h*	≈kg
200	2,5	300	300	532	560	340	295	8	22	170,0	138,0
250	2,5	300	425	716	500	395	350	12	22	265,0	173,0
300	2,5	310	400	700	500	445	400	12	22	380,0	177,0
350	2,5	340	440	800	560	505	460	16	22	520,0	230,0
400	2,5	450	520	895	735	565	515	16	26	650,0	470,0

*:1,5 m/s